

AMAZING MACHINERY

The Pressure Washer People 800-504-7435



OPERATOR'S MANUAL

TAG-A-LONG &
AUTO DETAILING PKG.
5.5hp, 11hp & 13hp
Gas Engine

READ THIS MANUAL

This manual contains important information for the use and safe operation of your AMAZING MACHINERY™ machine. **FAILURE TO READ THIS MANUAL AND FOLLOW ITS INSTRUCTIONS PRIOR TO OPERATING OR ATTEMPTING ANY SERVICE OR MAINTENANCE PROCEDURE COULD RESULT IN SERIOUS INJURY OR DEATH TO YOU OR OTHER PERSONS; ALSO DAMAGE TO THE MACHINE OR TO OTHER PROPERTY.**

Table of Contents

SECTION 1 OPERATOR'S MANUAL

■ UNPACKING.....	2
■ SAFETY INSTRUCTIONS AND WARNINGS.....	3
■ OPERATING INSTRUCTIONS.....	4

SECTION 2 PARTS AND SERVICE MANUAL

■ MAINTENANCE INSTRUCTIONS.....	5
■ PARTS DIAGRAM.....	6
■ PLUMBING DIAGRAM.....	7
■ HOSE, WAND, & GUN.....	7
■ PUMPS.....	8
■ TROUBLESHOOTING.....	9
■ WARRANTY.....	10

Unpacking Instructions

INSPECTION

Carefully unpack your new AMAZING MACHINERY equipment by removing the banding and cardboard box from pallet. Remove the pressure washer from the pallet and check for any physical damages that may have occurred during shipment. Check for all parts specified and shown in figure 1.



Figure 1

NOTICE

Information in this operator's manual is subject to change without notice.

AMAZING MACHINERY SHALL NOT BE LIABLE FOR TECHNICAL OR EDITORIAL ERRORS OR OMISSIONS CONTAINED HEREIN. This operator's manual contains information protected by copyright. No part of this operator's manual may be photocopied or reproduced in any form without prior written consent from AMAZING MACHINERY.

© AMAZING MACHINERY, 2005
All rights reserved. Printed in USA.

First Printing (August 2005)

Safety Guidelines



READ THIS FIRST! FAILURE TO READ AND OBSERVE ALL WARNING STATEMENTS COULD RESULT IN SEVERE BODILY INJURY OR DEATH, POSSIBLE INJURY TO OTHER PERSONS, DAMAGE TO MACHINE OR OTHER PROPERTY.

- DO NOT operate this machine in areas where open flames are not permitted. DO NOT store or use combustible materials on or near this machine. Use this equipment only in well ventilated areas. Failure to follow this warning may cause carbon monoxide build up, fire or explosion, and possible injury or death.
- DO NOT fill gasoline tank while engine is running. Allow engine to cool before refueling. Should gasoline be spilled, move the machine away from the area of the spill. Do not attempt to restart the machine until the gasoline has fully evaporated.
- DO NOT operate engine if air cleaner or cover directly over the carburetor air intake is removed.
- DO NOT touch hot mufflers, cylinders or fins, as contact may cause burns
- DO NOT operate this machine while under the influence of alcohol, drugs or while fatigued.
- DO NOT direct discharge stream at yourself or others. Risk of injection or injury may occur. Never put your hand or fingers over the spray tip. Do not try to stop or deflect leaks with your hand or body. Always face nozzle and wand to the ground when testing.
- DO NOT operate this machine WITHOUT wearing protective Eye Wear. Gloves, Hard Hat, Mask, Ear Plugs & Steel Toe Work Boots are also recommended, DO NOT wear loose clothing. Keep your body and clothing clear of the engine and discharge stream when the machine is running.
- DO NOT tie back or block trigger gun in OPEN position. Never leave the pressure washer unattended once you have started it. If you leave, shut down machine completely.
- DO NOT overreach or stand on an unstable support while operating this machine. Maintain good footing and balance.
- DO NOT permit this machine to run while unattended or for extended periods of time with trigger gun closed. Damage to pump may occur.
- DO NOT operate this machine in an unsafe manner or around unsupervised children. Keep all other personnel clear while operating this machine. This product should only be operated by trained personnel.
- DO NOT alter original factory settings prior to operating this machine. Risk of injury to yourself or other persons may occur.
- DO NOT remove hoses, guns, nozzles or any components while this machine is still hot or while it is running.
- DO NOT attempt to service this machine before reading the service manual.
- DO NOT use water with a temperature over 140 degrees Fahrenheit
- DO NOT operate this machine without knowing how to stop and bleed water pressures. Know all controls before using this machine.
- DO NOT spray caustic, acids or abrasive fluids through this machine.
- DO NOT permit water to freeze inside this machine. Pump and plumbing damage may occur.
- Use only recommended AMAZING MACHINERY™ parts when servicing this machine.
- AMAZING MACHINERY™ will not be held liable for any unauthorized modifications made to this machine. Any such action will void the warranty.

Operating Instructions

LOCATION GUIDELINES

- Locate the machine on a solid and level surface so that engine and pump crankcase oil lubricate components properly. Avoid areas where water can build up in the working area. Possible injury can occur caused by the surface becoming slippery from water build up.
- Locate the machine in a well-ventilated area and away from flammable materials or fumes. Be sure ventilation warnings are observed. Keep pressure washer at least 18" away from flammable materials.
- Locate the machine so the operator has easy access to the pressure washer and its controls. Locate the machine so that it is protected from external damage.
- To prevent damage and excessive hose wear, locate the pressure washer so that the hose does not cross traffic areas

STARTING THE MACHINE

Following the steps below will insure successful operation:

- Read this manual completely before attempting to start the machine.
- Check the gasoline tank and fill with a good grade of gasoline.
- Check the engine oil level and fill with SAE 30 weight *high-detergent* oil
- Check the pump oil level and fill with SAE 30w *non-detergent* oil if needed.
- Check water tank to ensure adequate level of water required for the job.
- Attach high pressure hose to base of spray gun.
- Install water nozzle at the end of wand, making sure it is clear of any obstructions.
- Pull trigger on gun until a steady stream of water comes out the nozzle. This purges any air in the system.
- Slide fuel switch to the RIGHT and slide choke switch to the LEFT (closed position).
- Turn ON/OFF switch (on engine) to "ON".
- Start gas engine and allow RPM to develop. Small Engines may kick back. Be careful not to hold cord too tightly.
- Let engine warm up for approximately 30 seconds and slide choke to "OPEN" position.
- Insert detergent siphoning tube into a DOT approved container and open the metering valve for detergent application.
- Check for leaks in the system and cycle trigger gun to insure bypass is adjusted correctly. Repair any leaks and correct unloader adjustment if needed. Turn off machine before attempting any repairs.

WASHING TECHNIQUES

- Washing from bottom up increases dwell time of soap and lessens vertical streaks.
- Turn soap metering valve "OFF" to purge system of soap
- Rinsing with cold water from top down will retard detergent reaction which will enhance the rinsing performance.
- Wash at 30 to 60 degree angles to prevent splashback.

STOPPING THE MACHINE

- Turn engine to "OFF".
- Pull gun trigger to release water pressure from system.
- Disconnect wand & gun assembly.
- Wind up pressure hose on hose reel.

Maintenance Instructions

MOVING, STORAGE

- Place machine in covered area when not in use to protect from elements. Protect machine from freezing in cold temperatures by storing in a heated location.

WINTERIZING

- Direct Drive Machines with Water Tank: To protect the machine from freezing temperatures while storing or transporting, pour antifreeze into partially full (1/8 full or less) water tank. Remove water nozzle from end of wand and carefully insert wand into opening of water tank. Start machine and run until antifreeze water mixture has circulated throughout the machine returning back to the water tank.

ENGINE MAINTENANCE

- Every time (before start): Check oil level.
- First 8 hours: Change oil with **SAE 30W High-Detergent Oil**.
- Every 25 hours: Change oil if operating under heavy load or high ambient temperature. Service air cleaner pre-cleaner.
- Every 50 hours: Change oil. Clean and inspect spark arrester if equipped.
- Every 100 hours: Service air cleaner cartridge, replace oil filter (if equipped), Clean oil cooler (if equipped), Clean cooling system.

PUMP MAINTENANCE

- Fill crankcase to dot on oil gauge window per specifications with the specific oil created by the pump manufacturer (i.e. **General Pump Oil**). Ensure the right oil for specific pump as it may vary.
- Change oil after **40 Hour Break-in Period**.
- Change oil every **Three Months or at 500 Hour Intervals** thereafter.

UNLOADER ADJUSTMENT

- All Amazing Machinery machines have the unloader correctly set at the the factory. Setting an unloader is a difficult job without the proper equipment and training. Should the need arise to change the unloader settings, please contact your local pressure washer dealer.

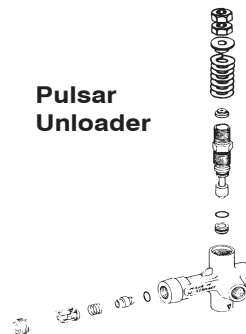



CHANGING THE UNLOADER SETTINGS WITHOUT THE PROPER EQUIPMENT AND TRAINING MAY RESULT IN NON-WARRANTY DAMAGE TO THE PUMP.

Parts Diagram

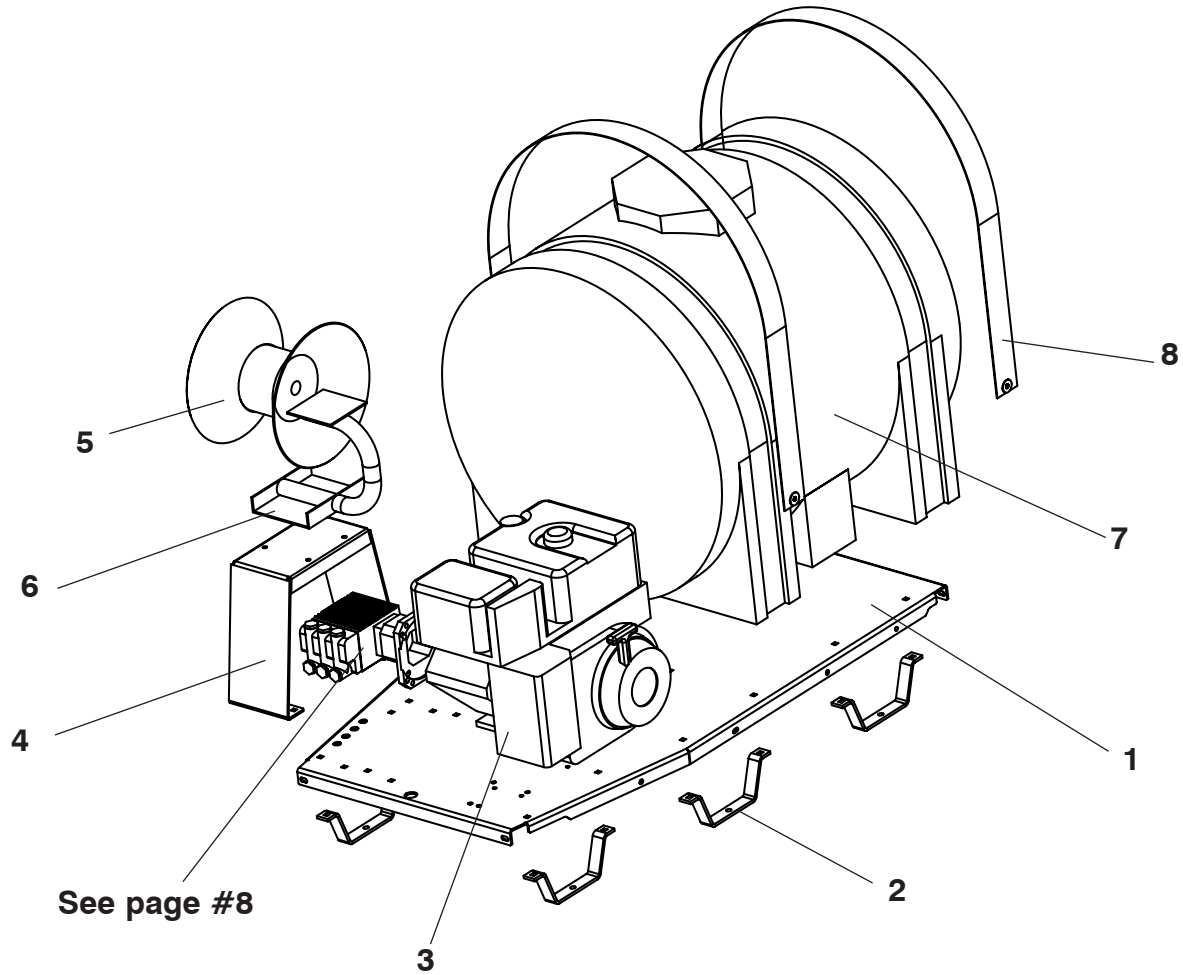

Ref.#	Part #	Description	Quantity
1	180-00390-01	Plate,cold water skid	1
(not shown)	620-00001-01	Big Wheel kit, 4'x54"	1
(not shown)	170-00011-01	Wheel,for Big Wheel kit,#08813	4
2	180-00030-01	Forklift Tine	6
3	206-00048-01	Engine,gas, 5.5hp Honda	1
3	206-00002-02	Engine,gas, 11hp Honda	1
3	206-00004-03	Engine,gas, 13hp Honda	1
4	180-00393-01	Stand,hose reel,cold water skid	1
5	595-00001-03	Hose Reel,16",RQ#4416 non-pivoting reel	1
6	595-00020-07	Base Mount,Reel Quick#2001.037	1
7	610-00005-03	Water Tank, 125 gallon	1
8	180-00377-01	Tank Strap, 125 gallon, Stainless Steel	2

Plumbing Diagram

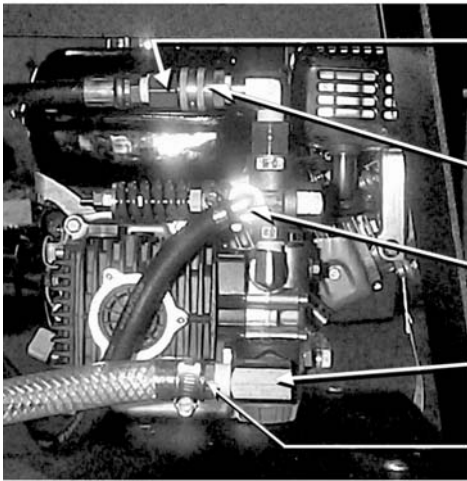

- QUICK CONNECT PLUG, 3/8 nptf
PART# 552-00004-03
- QUICK CONNECT COUPLER SOCKET, 3/8
PART# 554-00006-03
- BRASS ELBOW, 90°
3/8 nptm X 3/8 barb
PART# 530-00003-04
- STREET ELBOW, 90°
1/2 nptm X 1/2 nptm
PART# 530-00014-06
- HOSE BARB
1/2 nptm X 3/4 barb
PART# 554-00003-05

- STEEL ELBOW, 90°
3/8 nptf X 3/8 nptm
PART# 528-00002-02
- UNLOADER, BLUE SPRING
PULSAR#3HP
PART# 230-00011-02
- STEEL ELBOW, 90°
3/8 nptm X 3/8 nptm
PART# 528-00002-01
- WATER FILTER
1/2, GREEN CAP
PART# 577-00013-01
- STEEL ELBOW, 90°
3/8 nptf X 3/8 nptm
PART# 528-00002-02

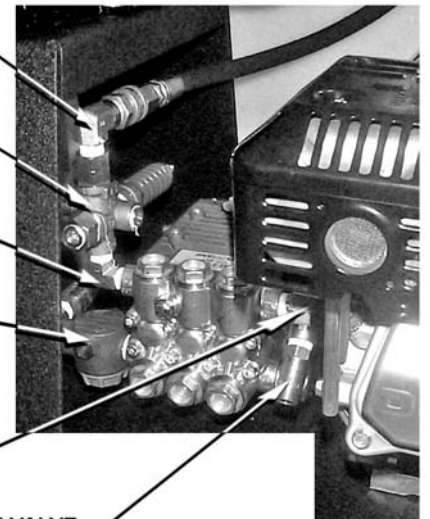

- POP-OFF VALVE
5000 PSI, #22533A
PART# 569-00003-10

Hose, Wand & Gun

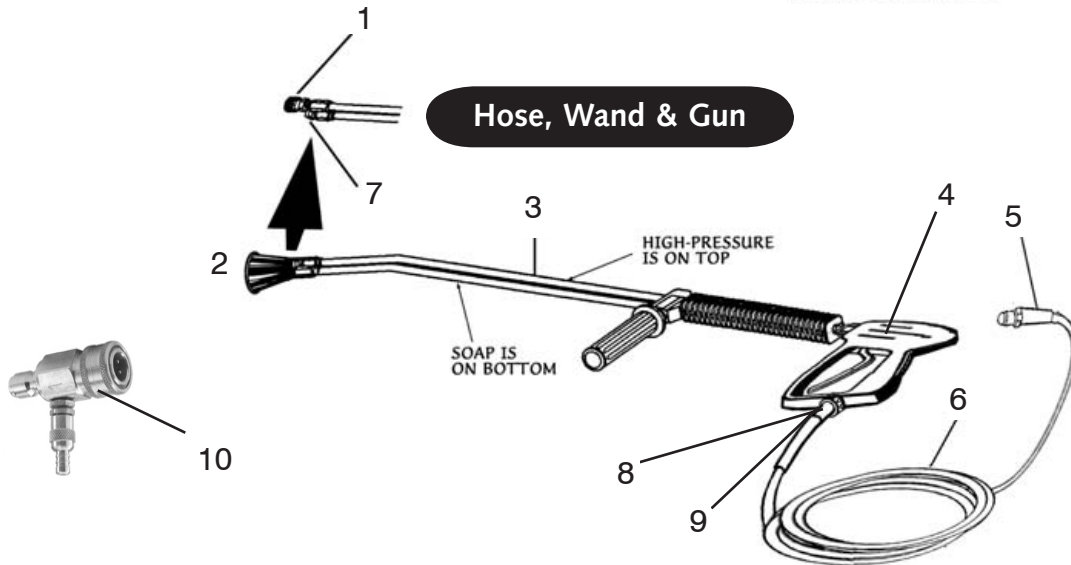

Ref#	Part#	Discription	Qty
1	270-00001-01	Nozzle, water, #3.5, 0° Quick Connect (5.5hp &13hp)	1
1	270-00001-02	Nozzle, water, #3.5, 15° Quick Connect (5.5hp &13hp)	1
1	270-00001-03	Nozzle, water, #3.5, 25° Quick Connect (5.5hp &13hp)	1
1	270-00001-04	Nozzle, water, #3.5, 40° Quick Connect (5.5hp &13hp)	1
1	270-00002-01	Nozzle, water, #4.0, 0° Quick Connect (11hp)	1
1	270-00002-02	Nozzle, water, #4.0, 15° Quick Connect (11hp)	1
1	270-00002-03	Nozzle, water, #4.0, 25° Quick Connect (11hp)	1
1	270-00002-04	Nozzle, water, #4.0, 40° Quick Connect (11hp)	1
2.	554-00006-02	Quick Coupler Socket, 1/4" Male	1
3.	065-00002-01	Dual lance, 8107-1101, Comet 15*, 43"SS	1
4.	275-00001-01	Gun, ST1500-01	1
5.	552-00004-03	Quick Coupler Plug, 3/8"	1
6.	284-00001-01	Hose Assembly, 50', 3000PSI @ 250°F	1
7.	270-00038-01	Nozzle, Soap	1
8.	552-00003-03	Quick Coupler Plug, 3/8 nptm	1
9.	554-00007-03	Quick Coupler Socket, 3/8 nptf	1
10.	020-00005-01	Downstream Injector Kit (hose not shown)	1

Comet LWD Pumps

all 5.5hp & 6.5hp units



Ref.#	Part #	Description	Qty.
1	220-00094-01	LWD 3020G Triplex Plunger Pump Complete (5.5hp)	1
1	221-00096-01	LWD 3025G Triplex Plunger Pump Complete (6.5hp)	1

Pump Repair Kits

221-00310-01	Check Valve Kit, All LWD Series Pumps	1
221-00300-01	Piston Kit, All LWD Series Pumps	1
221-00302-01	Seal Kit, All LWD Series Pumps	1

Comet ZWD Pumps

Select 11hp & 13hp units



Ref.#	Part #	Description	Qty.
1	220-00117-01	ZWD 3530G Triplex Plunger Pump Complete (11hp)	1
1	221-00114-01	ZWD 4040G Triplex Plunger Pump Complete (13hp)	1

Pump Repair Kits

221-00310-02	Check Valve Kit, All ZWD Series Pumps	1
221-00300-01	Piston Kit, All ZWD Series Pumps	1
221-00302-07	Seal Kit, All ZWD Series Pumps	1

General EZ Pumps

Select 11hp & 13hp units

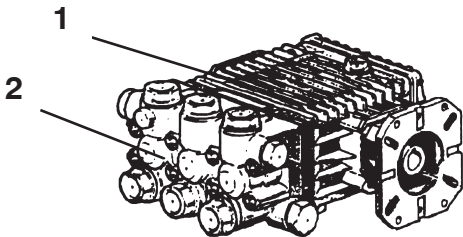

Ref.#	Part #	Description	Qty.
1	220-00015-01	EZ4035G Triplex Plunger Pump Complete	1
2	221-00001-04	Manifold, Brass Head EZ4035G	1

Pump Repair Kits

221-00021-01	Check Valve Assembly (Kit # 123), All EZ Series Pumps	1
221-00020-01	Oil Seal (Kit # 17), All EZ Series Pumps	1
221-00022-01	Oil Ring and Valve Cap (Kit # 124), All EZ Series Pumps	1
221-00041-01	Head Packing Complete (One Cylinder) (Kit # 156)	3
221-00040-01	V-Packing (Kit # 153)	1

Troubleshooting

problem	cause	action
Low Water Pressure	Insufficient water source Old or incorrect nozzle Plumbing or hose leak Obstruction in spray nozzle Chemical valve open Unloader valve worn Pump valves dirty or worn	Check hose size/water source Replace nozzle Tighten, repair or replace leak Clean or replace nozzle Close valve or submerge hose Replace unloader Clean or replace packing/valves
No Chemical Flow	Detergent valve closed Low detergent level Chemical screen dirty	Open detergent valve Fill detergent container Clean detergent screen
Pressure Relief Valve Leaks	Nozzle is dirty Defective relief valve Unloader adjusted incorrectly Restriction on discharge hose Scale restricting flow in coil	Clean or replace nozzle Replace relief valve Adjust unloader valve Remove nozzle and flush line Clean coil
Pump Motor Not Running	Pump motor switch off GFCI tripped No voltage to machine Clogged water nozzle Insufficient voltage/ampereage	Turn on pump motor switch Reset and test GFCI Check power source Clean water nozzle Use proper drop cord
Pump Noisy	Air in suction line Pump valves dirty Check valve springs worn Low pump oil Pump bearings are worn Incoming water too hot	Check inlet water fittings Clean/replace pump valves Replace check valves Add SEA 30wt. non-detergent Replace/rebuild pump Reduce temperature/ambient
Water In Oil	High humidity environment Oil seal worn Plunger packing worn	Change oil frequently Check and replace oil seal Check and replace packing
Water Dripping/Pump	Plunger packing is worn Plunger retainer oil ring worn Cracked ceramics	Install new packing kit Replace oil ring Replace ceramics
Oil Dripping	Oil seal worn Cracked manifold	Check and replace oil seals Replace manifold
Fluctuating Pressure	Unloader not adjusted Valves worn Dirt or blockage in valve Pump sucking air Worn plunger packing	Adjust to specifications Replace with valve kit Clean or replace valve Check water/detergent supply Replace packing kit
Pump Head Overheating	Extended period in bypass	Pull trigger gun for water flow

WARRANTY

MANUFACTURER LIMITED WARRANTY

ENGINES

Honda GC Series Engines; ONE Year from date of purchase Honda will repair or replace any manufacturer defect at their expense. To be handled directly by Honda Service Centers. See owners manual for details.

Honda GX Series Engines; TWO years from date of purchase Honda will repair or replace any manufacturer defect at their expense. To be handled by Honda Service Centers. See owners Manual for details.

Vanguard Series Engines; TWO years from date of purchase Briggs and Stratton will repair or replace any manufacturer defect at their expense. To be handled by Briggs and Stratton Service Centers. See owners Manual for details.

Robin Series Engines; TWO years from date of purchase Robin/Subaru will repair or replace any manufacturer defect at their expense. To be handled by Robin/Subaru Service Centers. See owners Manual for details.

Yanmar Diesel Engines; TWO years from date of purchase Yanmar will repair or replace any manufacturer defect at their expense. To be handled by Yanmar Service Centers. See owners Manual for details.

ELECTRIC MOTORS

Marathon and Baldor brand electric motors have a manufacture limited warranty of one year from purchase date to repair or replace the motor, at their options, any manufacturing defects.

The limited warranty does not include damage from low voltage or amperage use, high voltage or amperage use, water, or any other operator incurred damage.

PUMPS

Pump manufacturers offer a "one and five" limited warranty on tri-plex ceramic plunger type pumps, from date of purchase.

The body, head and power train of the pump is warranted for 5 years from date of purchase against manufacturer defects. See owners manual for details. The valves, packings and "o"rings are warranted for one year from date of purchase against manufacturer defects. See owners manual for details. Pump manufacturers offer a one year limited warranty on Axial Type pumps from date of purchase. See owners manual for details.

NOTE - Over Heated Pumps void all warranties.

ACCESSORY PARTS

Including, but not limited to; unloader valve, thermal relief valve, reels, easy start valve, chemical injector, rotating nozzles, spray tips, spray guns, wand extensions, telescoping wands, ball valves, sand injectors, quick couplers, high pressure hose, ground fault interrupter; all burner electronics and wiring, flow switches, diesel fuel injectors are warranted for repair or replacement by Equipment Manufacturer for a period of 90 days from date of purchase. Including, but not limited to; Surface Cleaners, Becket or Wayne Burners, Burner Fans and Heater Coils warranted against manufacture defects for repair or replacement by Equipment Manufacturer for a period of one (1) year from date of purchase. Including, but not limited to; Cart or Frame warranted against manufacture defects for repair or replacement by Equipment Manufacturer for a period of one (1) year from date of purchase.

LIMITATION OF LIABILITY

Amazing Machinery and Equipment Manufacturer liability for special, incidental, or consequential damages is expressly disclaimed. In no event shall any liability exceed the purchase price of the product in question. The warranty contained herein is in lieu of all other warranties express or implied, including any implied warranty of fitness for particular purpose.

NOTE - It is understood that a manufacturers limited warranty pertains to equipment used in it's prescribed manner, without abuse, and does not include wear and tear.

NOTE - All freight charges incurred on warranty situations are the responsibility of the customer.

Specifications, Warranties and Pricing are subject to change without notice.

*Refund does not include shipping/handling fees. No refund will be given for installation kits. Customer is responsible for lost or misdirected packages. It is recommended that the customer insure the package for its full retail value. This warranty does not cover or include any damage as a result of acts of God, improper installation, alteration, negligence or abuse.